

High performance liquid-solids separation systems

JPX

Exclusive internal acceleration creates the highest level of performance, achieving maximum protection for fluid handling systems from unwanted solids (see illustration inside for details). LAKOS advanced and patented design removes sand, grit and other fine solids from the source of process water/liquid systems, removing 98% of such particles at 200 mesh (74 microns) and larger (see maximum particle sizes, page 3). With heavier solids (metal chips, lead, etc.), expect even better results. Its unique centrifugal style of filtration is proven superior for today's demanding filtration requirements.

Trouble-free operation & advanced purging/solids-handling concepts keep fluids clean and concentrate separated solids

No screens or filter elements to clean or replace; no messy servicing routines

No backwashing; zero fluid loss options

Low & steady pressure loss

Choice of profiles to accommodate space/piping limitations

Rigid couplings for fast and easy internal access

Swirlex internal accelerating slots for optimum solids-removal performance; patented; optional annular transfer ring for handling larger solids/fibrous materials

Vortube for enhanced solids separation/collection; patented

Grooved inlet/outlet connections for easy installation; optional flanged connections also available

In-line inlet/outlet configuration for simplified piping (low-profile models only)

Fully assembled unit for easy installation

Optional: ASME code and other construction material



Flow range:
4 - 12,750 U.S. gpm
(1 - 2895 m³/hr)

Maximum standard
pressure rating:
150 psi (10.3 bar)



JPX Series includes inlet/outlet pressure gauges with petcock valves.



Also available with weld-on flanges.

How-it-Works Illustration

Model Specifications

Installation & Operating Instructions

Maintenance & Purging

Engineering Specifications



LAKOS is a proud member of the U.S. Green Building Council

How It Works

Automatic Purging

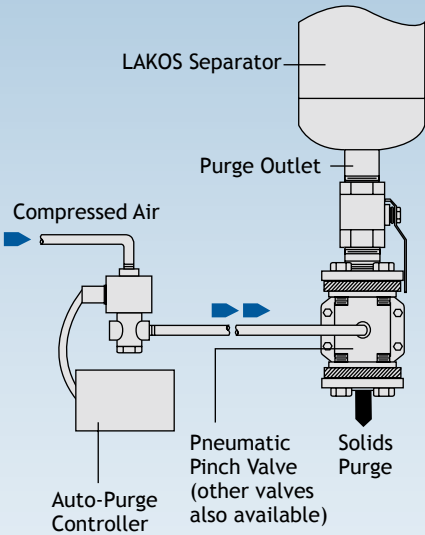

Solids Handling Options

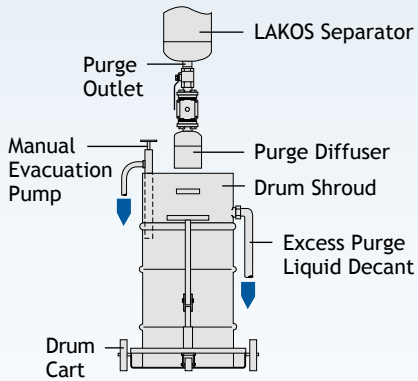

Systems also available with a tilt-style hopper.

Lakos Separators are manufactured and sold under one or more of the following U.S. Patents:
 5,320,747; 5,338,341; 5,368,735;
 5,425,876; 5,571,416; 5,578,203;
 5,622,545; 5,653,874; 5,894,995;
 6,090,276; 6,143,175; 6,167,960;
 6,202,543; 7,000,782; 7,032,760 and
 corresponding foreign patents, other
 U.S. and foreign patents pending.

Pressure gauges with petcock valves (included as standard) to monitor proper flow range (see "Flow vs. Pressure Loss", page 3)

Fluid and pressure drawn by Vortube to more positively allow even finer solids to be drawn into solids collection chamber (Separated, instead of entering vortex flow to outlet)

Manual Isolation Valve (recommended but not included with separator) provides for removal of Auto Purge valve for servicing

Solids Purge

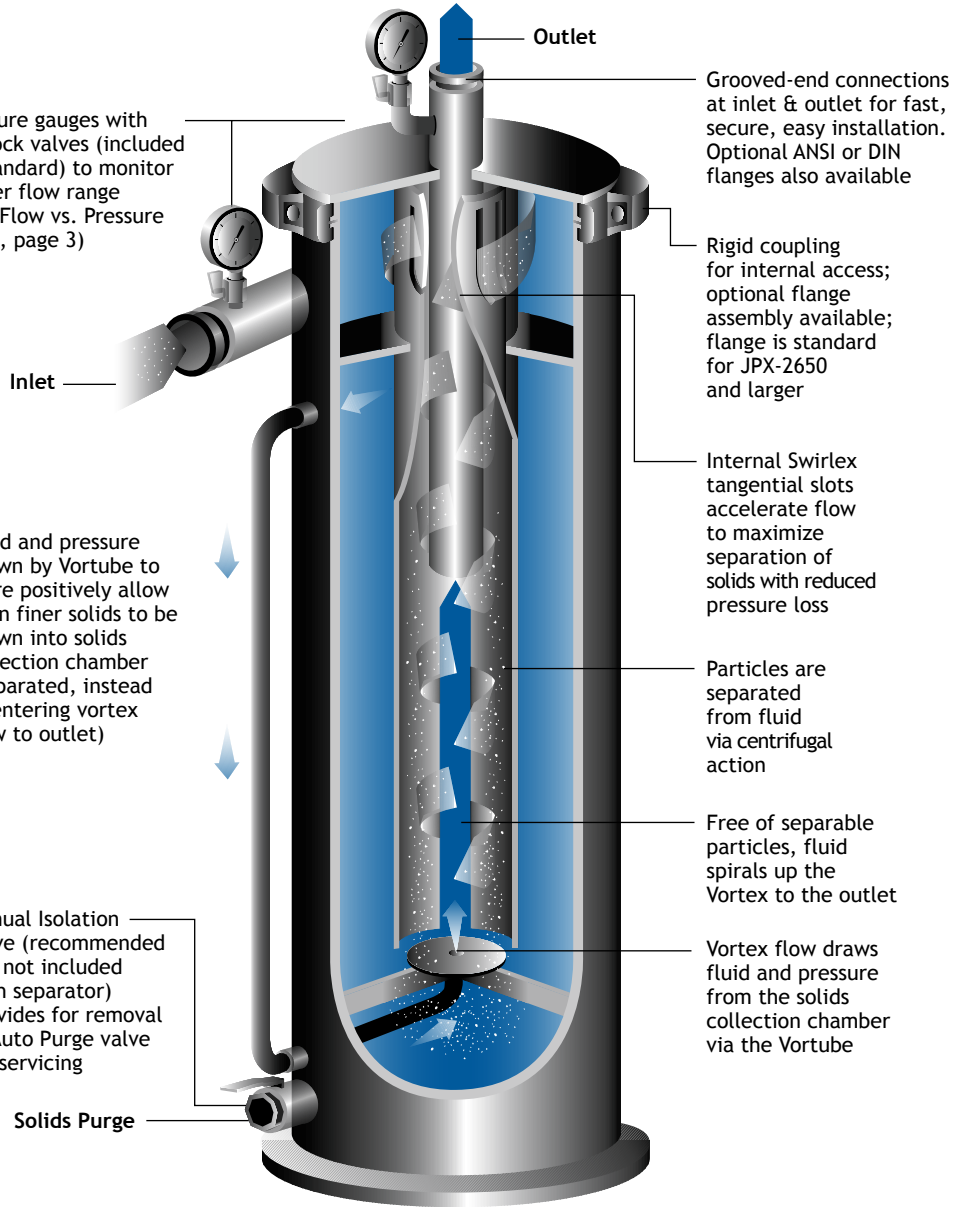

Performance

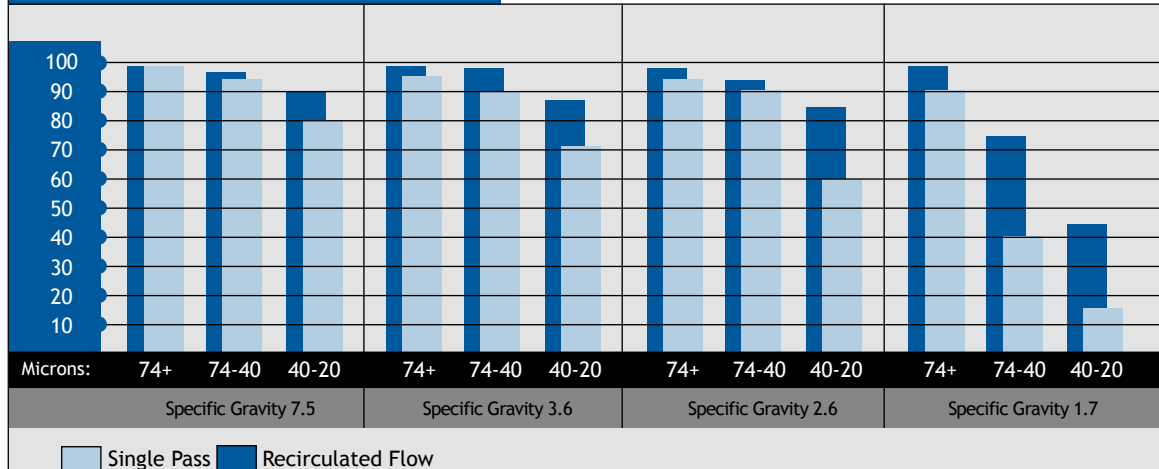

Carbon Steel Specifications***

Model*	Flow Range		Inlet/Outlet Size**	Connections***		Purge Size Male N.P.T.	Collection Chamber Capacity		Weight Empty		Weight with Water	
	U.S. gpm	m ³ /hr		Inlet/Outlet	Top Access		gal	liters	lbs.	kg	lbs.	kg
JPX-0004	4-10	1-2.5	1/2" NPT**	G	G	1"	0.09	0.3	23	10.4	37	16.8
JPX-0010	10-20	2.5-4.5	3/4" NPT**	G	G	1"	0.11	0.4	48	21.8	61	27.7
JPX-0016	16-30	4-7	1"	G	G	1"	0.15	0.6	53	24.0	68	30.8
JPX-0028	28-45	7-10	1-1/4"	G	G	1-1/2"	0.27	1.0	84	38.1	101	45.8
JPX-0038	38-65	9-15	1-1/2"	G	G	1-1/2"	0.4	1.5	107	48.5	140	63.5
JPX-0060	60-100	14-23	2"	G	G	1-1/2"	0.8	3.0	188	85.3	259	117.5
JPX-0085	85-145	19-33	2-1/2"	G	G	1-1/2"	0.8	3.0	229	103.9	313	142.0
JPX-0130	130-225	30-51	3"	G	G	1-1/2"	0.8	3.0	241	109.3	329	149.2
JPX-0200-L	200-325	45-74	4"	G	G	1-1/2"	1.6	6.1	448	203.2	640	290.3
JPX-0200-V				G	G		4.4	16.7	384	174.2	605	274.4
JPX-0285-L	285-525	65-120	4"	G	G	1-1/2"	2.1	7.9	579	262.6	898	407.3
JPX-0285-V				G	G		5.4	20.5	488	221.4	781	354.3
JPX-0450-L	450-825	102-187	6"	G	G	1-1/2"	2.8	10.6	763	346.1	1203	545.7
JPX-0450-V				G	G		6.7	25.4	690	313.0	1132	513.5
JPX-0650-L	650-1200	150-275	6"	G	G	1-1/2"	4.3	16.3	966	438.2	1664	754.8
JPX-0650-V				G	G		10.4	39.4	921	417.8	1578	715.8
JPX-1160-L	1160-2150	265-490	8"	G	G	1-1/2"	8.6	32.6	1388	629.6	2704	1226.5
JPX-1160-V				G	G		20.5	77.6	1378	622.3	2627	1191.6
JPX-1850-L	1850-3400	420-775	10"	G	F	2"	15.0	56.8	2141	971.1	4008	1818.0
JPX-1850-V				G	F		31.5	119.2	2255	1022.9	3977	1803.9
JPX-2650-L	2650-4900	600-1115	12"	G	F	2"	23.5	89.0	3664	1662.0	7732	3507.2
JPX-2650-V				G	F		51.1	193.4	3186	1445.1	6532	2962.9
JPX-4200-L	4200-7800	950-1775	16"	G	F	3"	52.2	197.6	6024	2732.4	13102	5942.9
JPX-4200-V				G	F		99.3	375.9	5761	2613.1	12867	5836.3
JPX-6700-L	6700-12750	1520-2895	20"	G	F	3"	81.0	306.6	8476	3844.6	19612	8895.8
JPX-6700-V				G	F		162.3	614.4	8092	3670.5	19339	8772.0

F = flanged connection
G = grooved connection

- * Models ending with "L" are low profile; "V" for vertical profile
- ** Inlet/Outlet may also be specified with ANSI flanges or DIN flanges; JPX-0004 and JPX-0010 are standard male, N.P.T. (BSP or JIS threads available); other models also available with optional threading
- *** For stainless steel specifications, including flanges and weights, consult the factory.
 - Maximum pressure rating: 150 psi (10.3 bar); consult factory for higher pressure requirements
 - Pressure loss range: 3 - 12 psi (.2-.8 bar). See chart below
 - Maximum temperature rating: 180°F (82.2°C) Consult factory for higher temperatures
 - Maximum particle size: JPX-0016 and smaller - .25 inch (6 mm); all other models - .375 inch (9 mm)
 - Material (standard carbon steel): Domes - A-234/516 Gr 70.
 - Outer Barrels and Nozzles - A-53B/106B or equivalent
 - Flat heads - A-36/516 Gr 70
 - Paint coating: Acrylic urethane, spray-on royal blue

Flow vs. Pressure Loss

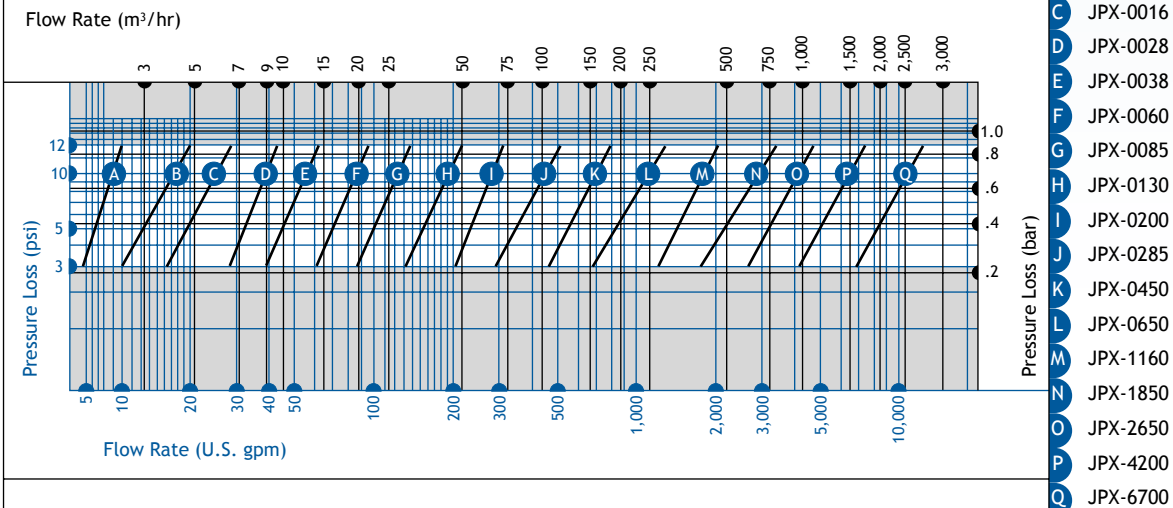

Installation Instructions

Maintenance/Purging

1. LAKOS JPX Separators must be purged regularly to remove the separated solids from the temporary collection chamber.
2. All purge hardware should be installed prior to any elbows or turns in the purge piping. Avoid “uphill” purging, which can clog purge piping and hinder effective solids evacuation.
3. For best results, purging is recommended while the LAKOS Separator is in operation, utilizing system pressure to enhance solids evacuation.
4. LAKOS provides a full selection of rugged, durable automatic purging and solids-handling systems to optimize the performance of your separation system.
CAUTION: Economy-type valves typically fail prematurely in the harsh/abrasive environment of solids purging.
5. Be sure to install a manual isolation valve (provided with LAKOS AutoPurge kits) prior to the automatic valve (available from LAKOS at additional cost) in order to facilitate servicing of the automatic valve without system shutdown.
6. Internal Access Feature:
To inspect or clear an unusual blockage in the upper or lower chamber, interrupt flow to the LAKOS Separator and relieve pressure (via the purge valve). For upper chamber access, remove the spool from the separator’s outlet (or, if no spool has been installed, disconnect and remove piping on the outlet) to make space for removing the separator’s upper section. Disconnect the rigid coupling or flange and carefully pull out the separator’s vortex outlet assembly. Inspect or clean the inlet chamber as necessary. Lubricate the coupling’s seal before re-installing the vortex assembly. Re-install piping and gaskets as necessary.

- 1 LAKOS JPX Separators are shipped on skids or in wooden crates. Support legs (when applicable) are detached for shipping. A large ring, located on the unit’s side or upper chamber, is provided for hoisting as necessary.
- 2 A suitable foundation is necessary to accommodate the LAKOS Separator’s weight including liquid (see data, page 3). Anchor bolts are recommended in the base of the legs (low profile) or skirt (vertical profile).
- 3 Prior to installation, inspect the inlet/outlet/purge connections for foreign objects incurred during shipping/storage.
- 4 Inlet/outlet pipe connections to the LAKOS Separator should be a straight run of at least five pipe diameters to minimize turbulence and enhance performance. Separator should not support piping.
- 5 Proper purge hardware and/or solids-handling equipment is required to flush separated solids from the separator (see details, page 2).
- 6 All LAKOS Separators operate within a prescribed flow range (see data, page 3). Pipe size is not a factor in model selection. Use appropriate hardware to match the inlet/outlet size. Grooved couplings are not included with the separator. Optional flanged connections are available upon request.
- 7 Inlet pressure to the LAKOS Separator must be at least equal to or greater than the anticipated pressure loss through the separator (see pressure loss chart, page 3) plus whatever downstream pressure is required.
- 8 Pressure gauges (provided as standard, with petcock valves) are required at both the inlet and outlet of the separator in order to monitor pressure loss and proper system flow (see “Flow vs. Pressure Loss” chart, page 3). If separator operates with an open discharge, a valve should be installed to create a back pressure of at least 5 psi (.3 bar).
- 9 Winterizing is important if the LAKOS Separator is to remain idle in freezing temperatures. Drain liquid as necessary to avoid expansion of water to ice and related damages.
- 10 See I & O Manual for additional information of standard units.

Low Flow Rates

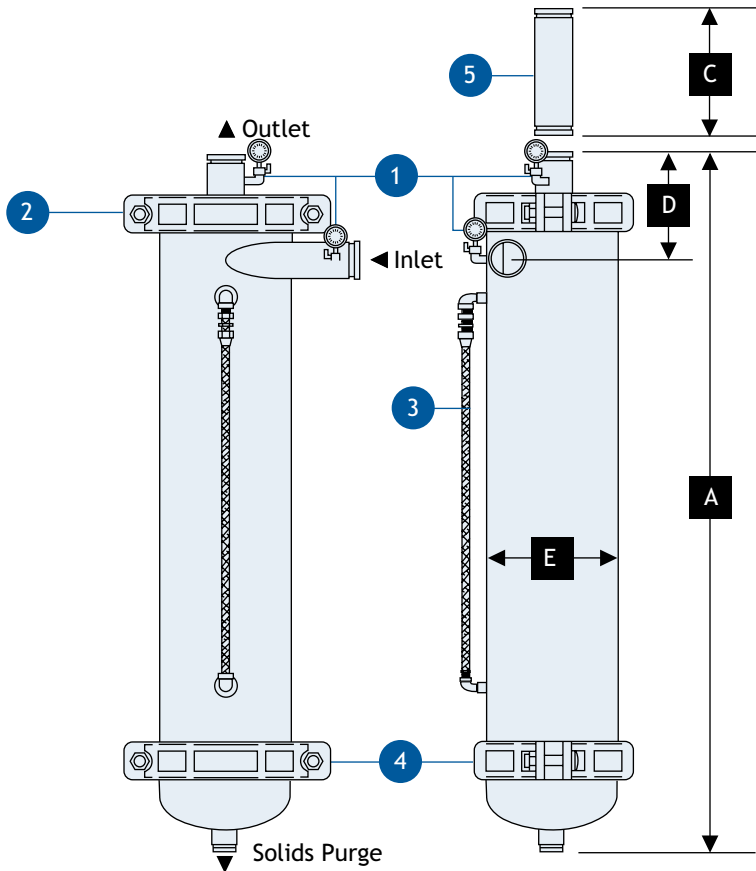

Top View

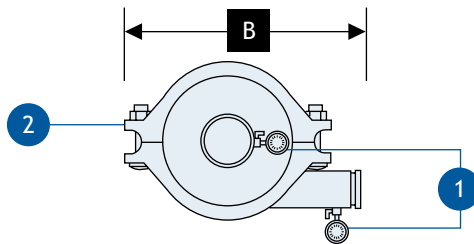

Dimensions

Model	A		B		C		D		E	
	in	mm	in	mm	in	mm	in	mm	in	mm
JPX-0004	27-9/16	699	7-1/2	191	6	152	7-5/8	194	3-1/2	89
JPX-0010	31-13/16	808	8-15/16	227	7	178	7-5/8	194	4-1/2	114
JPX-0016	33-1/8	842	6	152	7	178	7-15/16	202	4-1/2	114
JPX-0028	36-15/16	938	10-7/8	276	7	178	8-1/16	205	5-9/16	141
JPX-0038	39-1/2	1003	11	279	8	203	8-1/8	206	6-5/8	168
JPX-0060	48-13/16	1239	14-3/16	360	11	279	8-7/8	225	8-5/8	219
JPX-0085	56-5/8	1438	14-3/16	360	15	381	9-5/8	244	8-5/8	219
JPX-0130	59-3/4	1518	14-3/16	360	16	406	10-1/2	267	8-5/8	219

1 Inlet/Outlet Pressure Gauges with Petcock Valves

Included as standard; Install at both inlet and outlet for proper flow verification (see "Flow vs. Pressure Loss", page 3)

2 Rigid Coupling Connection

Provides for complete access to the upper chamber, acceleration slots and internal separation barrel; 2-piece; standard EPDM gasket - also available in Nitrile, Silicone, Fluoroelastomer or White Nitrile

3 Vortube

Piping provided by LAKOS

4 Rigid Coupling Access

Provides full access to collection chamber area for inspection/servicing; standard EPDM gasket - also available in Nitrile, Silicone, Fluoroelastomer or White Nitrile

5 Connection Spool

When removed, provides space for accessing internals of separator via rigid coupling. Not included with separator, available separately

Note: These units may also be specified with optional support skirt or legs. Consult factory for details.

Dimensions for reference only. Consult factory when pre-plumbing.

Low Profile

High Flow Rates

Inlet/Outlet Pressure Gauges with Petcock Valves

Included as standard; Install at both inlet and outlet for proper flow verification (see "Flow vs. Pressure Loss", page 3)

Inspection/Drain Plug

1/2-inch NPT female; provides access to upper chamber for inspection of slot area; also allows for draining the upper chamber if necessary

Rigid Coupling Connection

Provides for complete access to the upper chamber, acceleration slots and internal separation barrel; standard EPDM gasket - also available in Nitrile, Silicone, Fluoroelastomer, Black Neoprene or White Nitrile; model JPX-1850 and larger uses flange in carbon steel construction (JPX-0450 and larger in stainless steel construction)

Lifting Ring

For installation purposes

Connection Spool

When removed, provides space for accessing internal of separator via rigid coupling. Not included with separator, available separately

Hand-Hole Inspection Port

Provides access to collection chamber; Neoprene gasket

Vortube

Piping provided by LAKOS

*Dimensions for reference only.
Consult factory when pre-plumbing.*

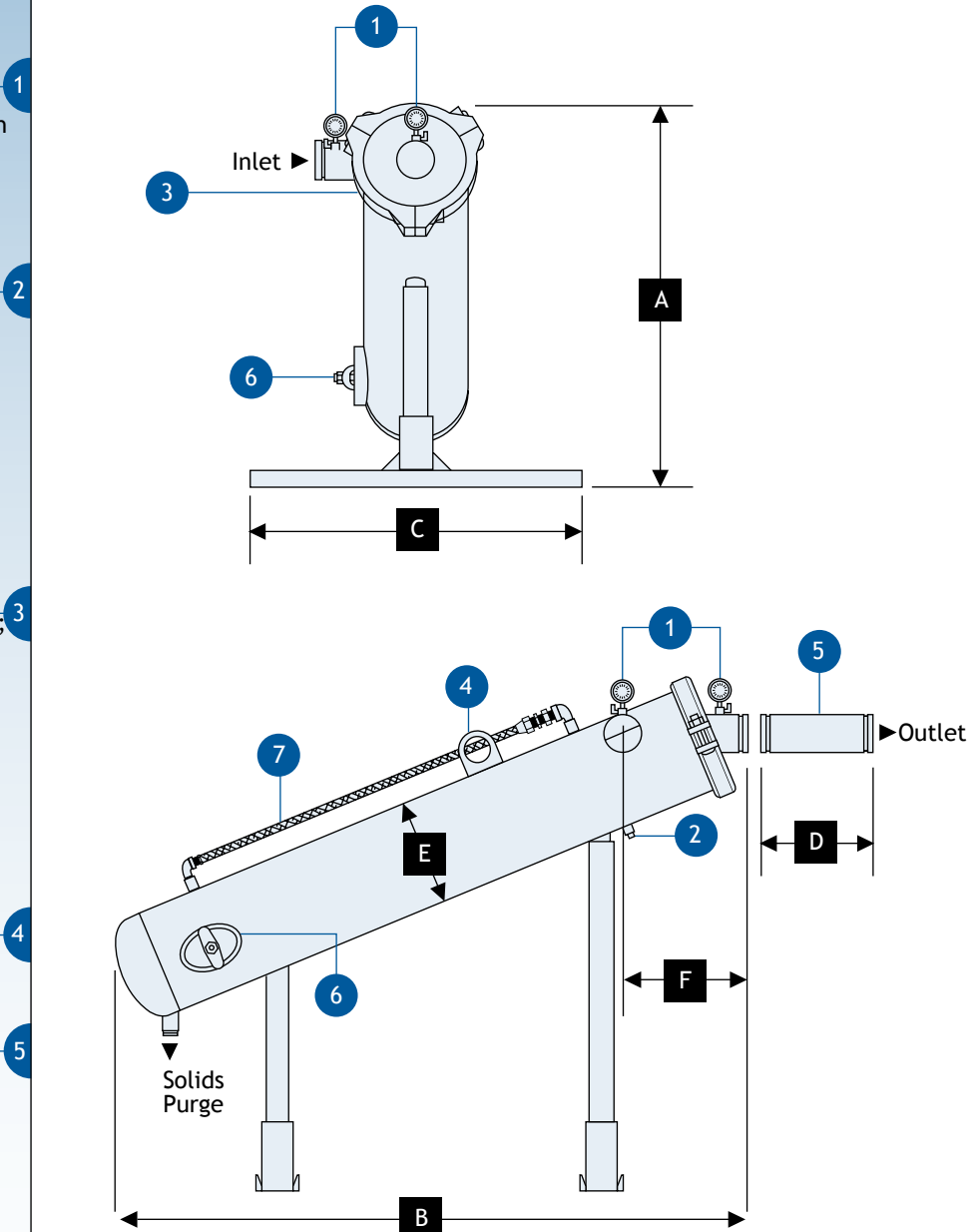

Dimensions

Model	A		B		C		D		E		F	
	in	mm	in	mm	in	mm	in	mm	in	mm	in	mm
JPX-0200-L	71	1803	65-1/4	1657	40	1016	21	533	10-3/4	273	13	330
JPX-0285-L	78-1/2	1994	79-5/8	2022	40	1016	21	533	12-3/4	324	15-7/8	403
JPX-0450-L	85-11/16	2176	94-5/16	2396	40	1016	24	610	14	356	15-1/4	387
JPX-0650-L	92	2337	106-1/8	2696	40	1016	24	610	16	406	17-7/8	453
JPX-1160-L	104-3/4	2661	127-3/16	3231	40	1016	30	762	20	508	21-13/16	554
JPX-1850-L	113-7/16	2881	150-3/8	3820	40	1016	33	838	24	610	34-1/8	867
JPX-2650-L	126-1/2	3213	165-13/16	4212	60	1524	38	965	28	711	37	940
JPX-4200-L	149-1/4	3791	208	5283	60	1524	51	1295	36	914	47-5/8	1210
JPX-6700-L	168-1/4	4274	244-1/2	6210	60	1524	60	1524	42	1067	53-1/2	1360

High Flow Rates

Vertical Profile

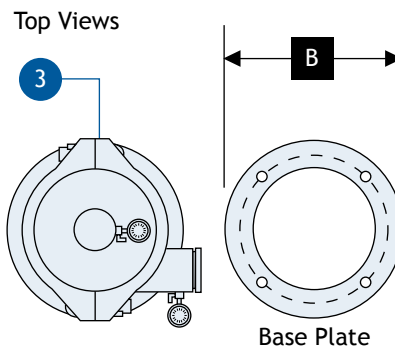
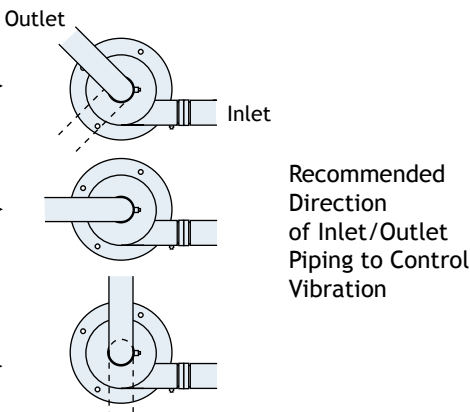
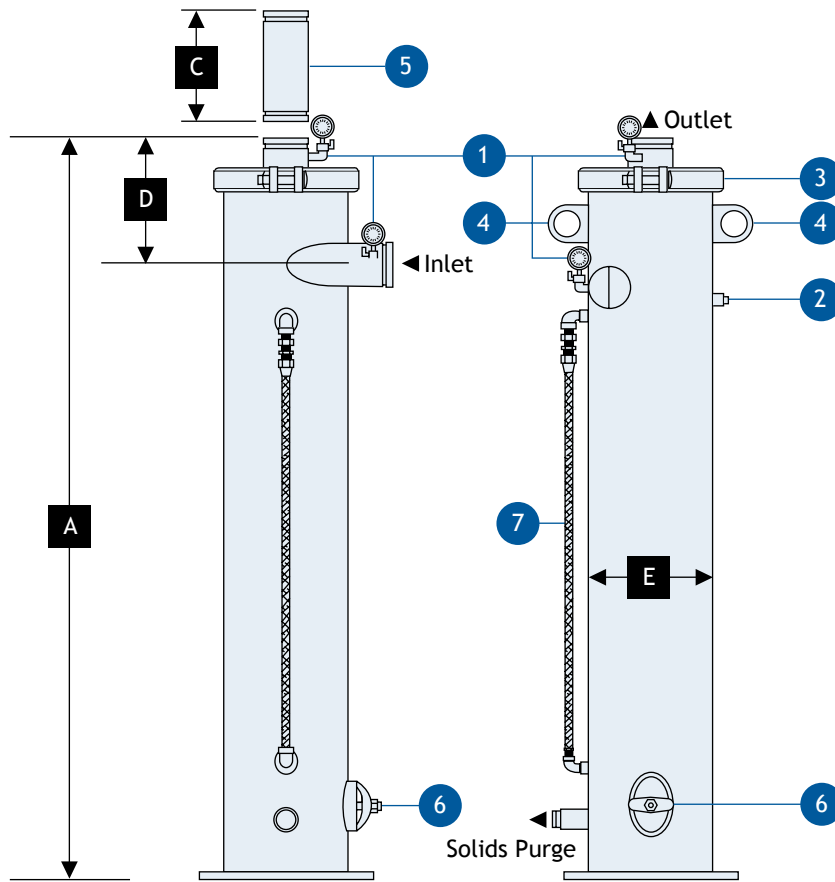

Dimensions

Model	A		B		C		D		E	
	in	mm	in	mm	in	mm	in	mm	in	mm
JPX-0200-V	73-13/16	1875	16	406	21	533	11-1/2	292	10-3/4	273
JPX-0285-V	79-9/16	2021	18	457	21	533	14-3/16	360	12-3/4	324
JPX-0450-V	94-5/8	2403	20	508	24	610	13-3/8	340	14	356
JPX-0650-V	107-3/8	2727	22	559	24	610	15-3/4	400	16	406
JPX-1160-V	128-1/8	3254	26	660	30	762	18-7/8	479	20	508
JPX-1850-V	148-5/16	3767	32	813	33	838	28	711	24	610
JPX-2650-V	168-3/4	4286	36	914	38	965	31	787	28	711
JPX-4200-V	205-3/16	5212	44	1118	51	1295	39-1/8	994	36	914
JPX-6700-V	244-3/8	6207	52	1219	60	1524	43	1092	42	1067

1 Inlet/Outlet Pressure Gauges with Petcock Valves

Included as standard; Install at both inlet and outlet for proper flow verification (see "Flow vs. Pressure Loss", page 3)

2 Inspection/Drain Plug

1/2-inch NPT female; provides access to upper chamber for inspection of slot area; also allows for draining the upper chamber if necessary

3 Rigid Coupling Connection

Provides for complete access to the upper chamber, acceleration slots and internal separation barrel; standard EPDM gasket - also available in Nitrile, Silicone, Fluoroelastomer, Black Neoprene or White Nitrile; model JPX-1850 and larger uses flange in carbon steel construction (JPX-0450 and larger in stainless steel construction)

4 Lifting Rings

For installation purposes

5 Connection Spool

When removed, provides space for accessing internal of separator via rigid coupling. Not included with separator, available separately

6 Hand-Hole Inspection Port

Provides access to collection chamber; Neoprene gasket

7 Vortube

Piping provided by LAKOS

Dimensions for reference only. Consult factory when pre-plumbing.

Limited Warranty

All products manufactured and marketed by this corporation are warranted to be free of defects in material or workmanship for a period of at least one year from date of delivery. Extended warranty coverage applies as follows:

All LAKOS JPX Separators: Five year warranty

All other components: 12 months from date of installation; if installed 6 months or more after ship date, warranty shall be a maximum of 18 months from ship date.

If a fault develops, notify us, giving a complete description of the alleged malfunction. Include the model number(s), date of delivery and operating conditions of subject product(s). We will subsequently review this information and, at our option, supply you with either servicing data or shipping instruction and returned materials authorization. Upon prepaid receipt of subject product(s) at the instructed destination, we will then either repair or replace such product(s), at our option, and if determined to be a warranted defect, we will perform such necessary product repairs or replace such product(s) at our expense.

This limited warranty does not cover any products, damages or injuries resulting from misuse, neglect, normal expected wear, chemically-caused corrosion, improper installation or operation contrary to factory recommendation. Nor does it cover equipment that has been modified, tampered with or altered without authorization.

No other extended liabilities are stated or implied and this warranty in no event covers incidental or consequential damages, injuries or costs resulting from any such defective product(s).

Sample Specifications

Sample specifications can be downloaded from the LAKOS website at www.LAKOS.com.

Multi-Stage Separators

Separators installed in a series (outlet to inlet) will:

- Effectively handle higher solids concentrations
- Improve fine particle removal performance

Combining LAKOS Separators in a “Bi-Sep” or “Tri-Sep” configuration, the first-stage separator will always most effectively remove larger solids, which are easily influenced by centrifugal action. Often, it is the larger solids that make up a great percentage of the overall solids volume. When finer, yet separable solids are also present and larger solids have limited the space available on the perimeter of the separation barrel, the second-stage separator then performs to remove even more of the finer solids.

Essentially, removing the larger solids in the first-stage separator effectively reduces the overall solids concentration, allowing the second-stage separator to more easily handle the lower solids concentration and the smaller particles. And, in applications where the particle geometry is flakes, rods and/or irregular shapes, two-stage separators have been utilized to successfully increase overall particle-removal.

JPX Low Profile (Bi-Sep)

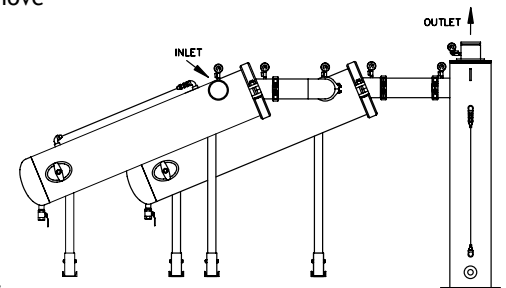
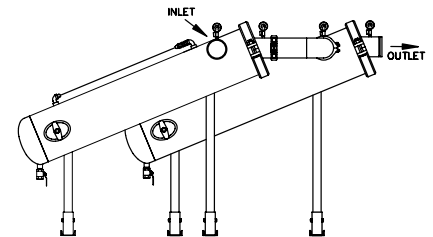

JPX Low Profile and Vertical Profile (Tri-Sep)

Annular Transfer Ring

For larger solid particles. Used in applications where fibrous solids require alternative internal acceleration. Available for JPX-0200 and larger.

When large or fibrous solids are present, the Annular Transfer Ring offers an alternative means for internal acceleration to achieve maximum centrifugal action performance. The full-around annular open area resists clogging by large or stringy contaminants.

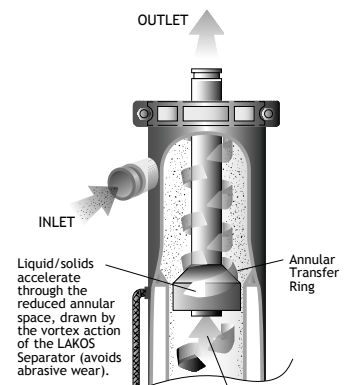

1365 North Clovis Avenue
Fresno, California 93727 USA
Telephone: (559) 255-1601
FAX: (559) 255-8093
www.lakos.com
info@lakos.com